

**Jones Brothers**  
**MARINE**

**Bateau**  
**Owner's Manual**

# **Bateau Owner's Manual**

**© Copyright Jones Brothers Marine Manufacturing, Inc. 2022**

This document may be reproduced by registered Jones Brothers Marine boat owners, provided its source is acknowledged and this notice is displayed in a prominent location within the manual. Unauthorized use, reproduction or distribution of this document in any way, shape, or form is strictly prohibited.

This Owners Manual is intended for use as a guide only, and does not take the place of safe operator practices.

Products that are referred to in this document may be either trademarks and/or registered trademarks of the respective owners. The publisher and the author make no claim to these trademarks.

While every precaution has been taken in the preparation of this document, the publisher and the author assume no responsibility for errors or omissions, or for damages resulting from the use of information contained in this document or from the use of programs and source code that may accompany it. In no event shall the publisher and the author be liable for any loss of profit or any other commercial damage caused or alleged to have been caused directly or indirectly by this document.

Printed: October 2022 in Morehead City, NC

# Table of Contents

<b>Part I</b>	<b>WELCOME</b>	<b>1</b>
<b>Part II</b>	<b>OVERVIEW</b>	<b>3</b>
	Responsibilities .....	4
	Warranty .....	5
	Boat Registration .....	5
	Insurance .....	5
<b>Part III</b>	<b>BOATING SAFETY</b>	<b>7</b>
	Safety Awareness .....	8
	Advisory .....	8
	Hazard .....	8
	Rules of the Road .....	9
	Right of Way .....	9
	Overtaking/Passing .....	10
	Meeting Head-On .....	10
	Crossing Situations .....	10
	Warning Signals .....	10
	Drugs and Alcohol .....	10
	Required Safety Equipment .....	10
	Fire Extinguisher .....	10
	Personal Flotation .....	11
	Horn .....	11
	Visual Distress Signals .....	11
	Registration Numbers .....	12
	Lighting .....	12
	Additional Recommended Equipment .....	12
	Load Capacity .....	13
	Engine Safety Lanyard .....	15
	Weather .....	16
	Storms .....	16
	Fog .....	16
	Emergency Conditions .....	17
	Person Overboard .....	17
	Capsizing .....	17
	Fire .....	17
	Collision .....	18
	Running Aground .....	18
	Accident Reporting .....	18
	Rendering Assistance .....	18
	Boating Safety Tips .....	19

<b>Part IV</b>	<b>GENERAL BOATING INFORMATION</b>	<b>21</b>
	Trailer	22
	Trailer Checklist	22
	Disc Brakes and the Reverse Lockout	23
	Driving	25
	Fueling	25
	Preliminary Procedures	25
	Fueling Procedures	25
	Fuel Capacity	26
	After Fueling Procedure	26
	Launching	26
	Pre-Start Checklist	27
	Starting	27
	Docking and Leaving the Dock	28
	General Information on Boat Handling	28
	Towing or Being Towed	29
	Anchoring	29
	Recovery	30
	Daily Cleanup and Storage	30
<b>Part V</b>	<b>OPERATION</b>	<b>33</b>
	Performance	34
	Engine	34
	Propeller	35
	Trim	35
	Trim Tabs	36
	Throttle/Shift Control	37
	Steering	38
	Switch Panel	39
	Fuse Panel	40
	Single Engine, One Battery with a Cut-Off Switch	41
	Single Engine, Two Batteries and one Dual Battery Switch	42
	House Switch	46
	Bilge Pump Wiring	47
	Rod Storage	47
	Plugs and Through Hull	48
	Livewell	49
	Washdown Faucet	50
<b>Part VI</b>	<b>MAINTENANCE AND SERVICE</b>	<b>51</b>

---

Exterior .....	52
Fiberglass Finish .....	52
Repairing .....	53
Bottom Paint .....	53
Canvas .....	53
Upholstery .....	54
Plexiglas .....	55
Scuppers .....	55
Caulking .....	55
Hardware Mounting .....	55
Hardware/Stainless Steel Rails Maintenance .....	55
Fuel System .....	56
Engine Battery .....	56
<b>Part VII WINTERIZATION AND STORAGE</b> .....	<b>57</b>
Boat Storage .....	58
Cleaning and Lubricating the Boat .....	58
Draining the Boat .....	58
Fuel System .....	59
Batteries .....	59
Engines .....	59
Storage Checklist .....	59



**WELCOME**

**Part**



# 1 WELCOME

Dear Bateau Owner:

Welcome to the Jones Brothers family! Thank you for choosing a Jones Brothers Marine Bateau! We're sure that you'll be completely satisfied with the unmatched performance, quality and fishability of your new boat.

The Bateau was designed for safe and comfortable operation in coastal marshes, nearshore waters, and reservoirs of the eastern United States. The boats are tough-as-nails, wide, stable, and easily trailered. They are also economical to run, since flat-bottom boats don't need the larger engines that are often required to power V-hulled boats.

Each boat is constructed using the finest materials available today, and our constant attention to detail from layup to final finish, insures the most value for your investment. An investment that will hold its value for years to come.

In addition, each boat is built to exacting Jones Brothers Marine standards which exceed all U.S. Coast Guard safety standards and is built to standards certified by the National Marine Manufacturers Association (NMMA) and the American Boat and Yacht Council (ABYC).

The seaworthiness and safety of your Bateau is highly dependent on planning, preparation, operation, and maintenance. Please read this manual and all other materials supplied with your boat. Keep them in a safe, dry place for easy reference.

If you need further explanation or hands-on help, don't hesitate to ask the people at your dealership. If for any reason you need further help, please feel free to call us at the factory. We sincerely want to provide you with the help and information that will make your Jones Brothers Marine experience a delightful one.

All of us at the factory and at your dealership are dedicated to earning your confidence in Jones Brothers Marine.

Thank you again for choosing a Bateau.

Donnie Jones  
Jones Brothers Marine Manufacturing  
100 Bateau Blvd  
Morehead City, NC 28557

email: [donnie@jonesbrothersmarine.com](mailto:donnie@jonesbrothersmarine.com)  
tel: 252-240-1995  
fax: 252-240-1980



# OVERVIEW

**Part**

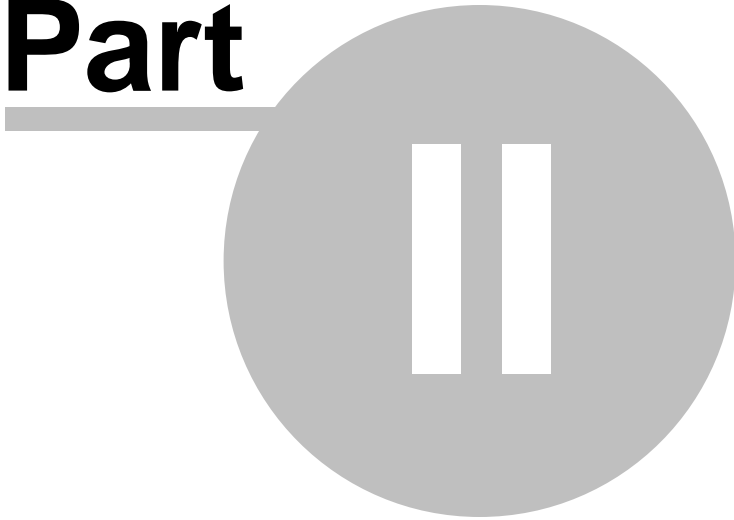

## 2 OVERVIEW

Your Bateau Owner's Manual contains all the necessary information on the care and operation of all current models. Most major systems (engine, electronics, etc.) come with their own instruction manuals. The information in these manuals should be considered part of this manual. The suppliers of these products maintain their own manufacturer's warranty and service facilities. **IMPORTANT:** Fill out and return each warranty card to inform the manufacturer that you are a registered owner of their product.

Your Bateau Owner's Manual provides an overview of all systems and components on your skiff. Additional information can be found in the supplied manufacturer's literature, boating reference books (available at various book stores) or at the local library.

### 2.1 Responsibilities

The following sections outline the responsibilities for both you and your Jones Brothers Marine dealer. This ensures that you will receive maximum performance and enjoyment from your new skiff.

#### DEALER

Your authorized Jones Brothers Marine dealer will be responsible to you for the following:

- Ensuring that you know the general operating procedures for your boat and that you are familiar with its specific systems and components.
- Reviewing the pre-delivery service record with you, then signing it to certify that it is correct.
- Providing instructions on how to get warranty service.
- Discussing the terms of all warranties and stressing the importance of registering each warranty with its respective manufacturer.

#### OWNER

As the owner, you are responsible for:

- Using all equipment in accordance with the manufacturer's instructions.
- Scheduling an appointment with your dealer to review all warranties and then completing the Jones Brothers Marine, Inc. Limited Warranty registration card (record the hull number for future reference).
- Scheduling an appointment with your dealer to review the pre-delivery engine service record, then signing it to indicate that the dealer has provided a complete explanation.
- Inspecting the physical condition of the boat at the time of delivery and making sure that all systems and components are operating properly.
- Scheduling your boat's 20 hour checkup.
- Providing periodic maintenance as outlined in the Bateau Owner's Manual and all applicable manufacturer's service guides.

- Discussing the terms of all warranties and stressing the importance of registering each warranty with its respective manufacturer.

## 2.2 Warranty

In the unlikely event a problem should arise with your Bateau, contact your Jones Brothers Marine dealer as soon as possible. Please have your hull identification number and necessary model numbers on hand for the item(s) needing service or repair. Your hull identification number is located on the starboard side of transom and will always begin with the letters JBS. An accurate copy of it may be made using a pencil to stencil the outline on a piece of paper.

## 2.3 Boat Registration

Federal and state laws require that every boat equipped with propulsion machinery of any type must be registered in the main state of usage. Registration numbers and validation stickers must be displayed on the boat according to regulations. The registration must be carried onboard when the boat is in use.

## 2.4 Insurance

Insurance on your boat should be obtained as soon as possible for protection against loss by fire, theft, nature, etc. Many states have laws requiring minimum amounts of insurance coverage. Contact your insurance agent for more information.



# BOATING SAFETY

## Part

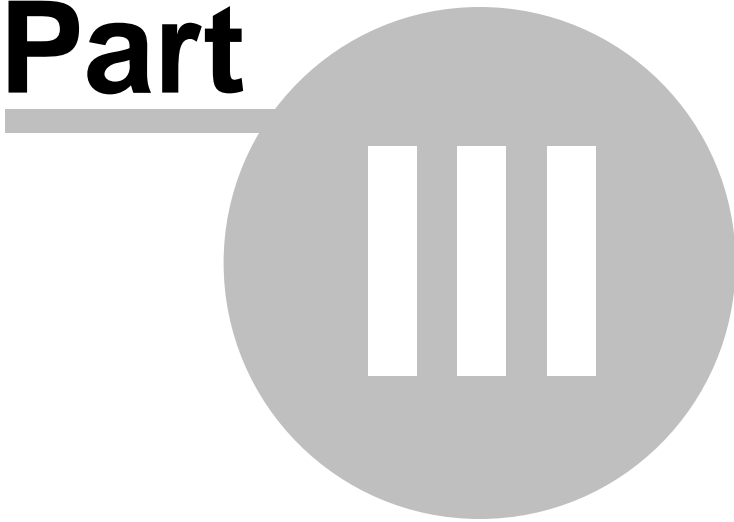

## 3 BOATING SAFETY

Like a car, boats must be operated according to safety rules and traffic regulations. Although we include some basic boating tips in this manual, a thorough review of the safety rules and regulations for boating is beyond the scope of this manual.

The local US Coast Guard Auxiliary and the US Power Squadrons offer comprehensive safe boating classes several times per year. You can contact the Boat/US Foundation at (800) 336-2628 for a course schedule. You can also contact the US Coast Guard Auxiliary or Power Squadron Flotilla for the time and place of the next scheduled class in your area.

For online information, visit:

**US Coast Guard Auxiliary** <http://www.cgaux.org>  
**US Power Squadrons** <http://www.usps.org>

The Coast Guard also publishes several other helpful pamphlets, including the Boating Safety Training Manual, Federal Requirements for Recreational Boats and Aids to Navigation (US Coast Guard pamphlet #123), which explain the significance of various lights and buoys.

**IMPORTANT:** Coast Guard regulations and information change periodically. Prior to operating any vessel, you should always be aware of the most recent publications, notice and regulations then in effect.

### 3.1 Safety Awareness

The Jones Brothers Marine owner's manual uses five levels of advisory and hazard statements to alert you to special information, operating procedures or safety precautions. All statements begin with a signal word or symbol to identify the importance of the statement. The statement levels in the following Advisory and Hazard sections follow this order in increasing importance.

#### 3.1.1 Advisory

Advisory statements signal conditions that effect equipment operation, maintenance and servicing practices and occur in two levels:

##### **Level 1 - NOTE**

Signals a general advisory statement that clarifies or highlights a particular section of text.

##### **Level 2 - IMPORTANT**

Used to signal the possibility of damage to equipment or associated components.

#### 3.1.2 Hazard

The use of hazard statements is determined by the likely consequence of the warning with regard to severity (minor injury, severe injury, death), and the probability of severity (COULD result in, WILL result in). Not following the recommendations contained in any of these statements may result in personal injury.

### Level 3 - CAUTION



Hazards or unsafe practices that COULD result in minor personal injury.

### Level 4 - WARNING



Hazards or unsafe practices that COULD result in severe personal injury or death.

### Level 5 - DANGER



Immediate hazards that WILL result in severe personal injury or death.

## 3.2 Rules of the Road

Your Jones Brothers Marine boat is subject to marine traffic laws known as Rules of the Road. There are two sets of rules: The United States Inland Navigational Rules and the International Rules. The US Inland Rules are applicable to all vessels inside the boundary lines separating inland and international waters.

These rules can be obtained from your local US Coast Guard Unit or the US Coast Guard Headquarters (1300 E Street NW, Washington, D.C. 20226) in the publication titled, Navigational Rules, International-Inland. In no case will rules or regulations make up for poor judgment, lack of common sense or courtesy. They are also available online at: [http://www.navcen.uscg.gov/mw/navrules/rotr\\_online.htm](http://www.navcen.uscg.gov/mw/navrules/rotr_online.htm)

The follow topics are a brief synopsis of The Rules. They are only a general summary and are in no way meant to act as a replacement for The U.S. Coast Guard Rules of the Road, nor are they intended to act as a substitute.

### 3.2.1 Right of Way

Sail vessels have the right of way over powerboats in nearly all cases, unless they are under power by propulsion machinery (engine). Boats being paddled have the right of way over powerboats. Stay clear of these craft and do not create a wake which may cause them trouble.

In narrow channels, small powerboats must yield to large commercial vessels and must not hamper their operation. Keep your distance from all commercial vessels and other large craft. A large vessel has limitations in maneuverability.

### 3.2.2 Overtaking/Passing

In overtaking and passing situations, the boat being passed has the right of way, the passing boat is required to stay clear.

### 3.2.3 Meeting Head-On

When meeting head-on, neither boat has the right of way. Both boats should keep to their right and pass on the left. However, if both boats are on the left side of the channel, each vessel should sound two short blasts of the horn and pass on the right sides.

### 3.2.4 Crossing Situations

In crossing situations, the boat on the right has the right of way. It must hold its course and speed. The other vessel must slow down and stay clear until the other vessel has passed. Boats going up and down a river have the privilege over boats crossing the river.

### 3.2.5 Warning Signals

The following warning signals and their meanings are commonly used by vessels on the water. Common sounding devices include horns or whistles.

<b>ONE LONG BLAST</b>	Warning signal - coming out of slip
<b>ONE SHORT BLAST</b>	Pass on my port side
<b>TWO SHORT BLASTS</b>	Pass on my starboard side
<b>THREE SHORT BLASTS</b>	Engine in reverse
<b>FIVE OR MORE BLASTS</b>	Danger Signal

### 3.2.6 Drugs and Alcohol

DO NOT use drugs or alcohol while boating. The operation of a motorized vessel while under the influence carries a significant penalty and is strictly enforced by the U.S. Coast Guard, state and local law enforcement agencies. The use of drugs or alcohol will decrease your reaction time, impair your judgment and keep you from safely operating your boat.

## 3.3 Required Safety Equipment

The US Coast Guard (USCG) requires that every boat have specific equipment on board. Refer to the US Coast Guard publication CG-290 for more information on Coast Guard required safety equipment. Some local regulations request more equipment than this list of the USCG requirements:

### 3.3.1 Fire Extinguisher

Every boat should be equipped with a fire extinguisher that is approved for marine use. It should be classified to extinguish Type B (gasoline, oil or grease) fires. Your fire extinguisher should be readily available. Passengers should be informed of its location and proper use. Check extinguisher periodically for status of charge.

If your fire extinguisher has a charge indicator on the gauge, cold or hot weather may have an affect on the gauge reading. Consult the instruction manual supplied with the fire extinguisher to determine the accuracy of the gauge.



### 3.3.2 Personal Flotation

All passengers must have a U.S. Coast Guard approved personal flotation device (PFD). PFDs must be obtainable at anytime. PFDs must be in good condition and the appropriate size for the intended wearer. Small children and non-swimmers are advised to wear a PFD at all times. In addition to PFDs, a Type 4 throwable flotation device such as a ring buoy or boat cushion is also required.

Types of PFDs:

Type I	This PFD has the greatest buoyancy. It is designed to turn an unconscious person in the water from a face down to a vertical or slightly backward position. Type I is the most effective for all waters and especially further out where rescue may be delayed.
Type II	Turns the wearer into the same position as Type I but the turning action is not as pronounced because it is less buoyant. The Type II is generally more comfortable than a Type I.
Type III	Allows the wearer to place themselves in a vertical or slightly backwards position. The Type III has the same buoyancy as the Type II. It has little or no turning ability and may not be adequate in rough waters.
Type IV	The Type IV PFD is designed to be thrown to a person in the water and held until rescue. It is not designed to be worn. The most common Type IV PFDs are buoyant cushions or ring buoys. The Type IV shall be immediately accessible and in good condition.

**IMPORTANT:** Drowning remains the single most prevalent cause of boating fatalities, and each year the Coast Guard data shows that approximately 8 out of 10 of these victims are not wearing a life jacket. Wearing a life jacket is the single most important precaution boaters can take to ensure their personal on-water safety. Like seat belts, life jackets only work when worn. Today's life jackets are attractive, functional and comfortable to wear for extended periods. For more information, visit the website for the Personal Flotation Device Manufacturers Association and download their "Facts about Lifejackets" pamphlet:

<http://www.pfdma.org/library/downloads/documents/pfdmabrochure.pdf>

### 3.3.3 Horn

All Class 1 boats are required to carry a hand, lung, or power operated horn that is audible for at least one mile. If your Bateau is equipped with a horn, it meets USCG requirements.

### 3.3.4 Visual Distress Signals

USCG approved visual distress signals are required when operating on U. S. waters. When boating, these devices should be functional. Examples include: flares, orange smoke, orange flag (day use), or an electric distress light (night use).

A pyrotechnic or non-pyrotechnic Visual Distress Signal is required. Regulations require this equipment on all recreational boats used in coastal waters, including the Great Lakes and the territorial seas, to a point where the waters are less than two miles wide. This also applies to boats owned in the United States when operating on the high seas.

Pyrotechnic and non-pyrotechnic equipment must be US Coast Guard approved, in good operating condition and in a readily accessible location. Equipment with a maximum serviceable life must not have expired.

### **Pyrotechnic Equipment**

US Coast Guard approved pyrotechnic visual distress signals and associated equipment includes:

- Red flares, hand held or aerial
- Orange smoke, hand held or floating
- Launchers for aerial red meteors or parachute flares

### **Non-Pyrotechnic Equipment**

- Orange distress flag
- Electric distress light

No single signaling device is ideal under all conditions for all purposes. Consideration should be given to carrying various types of equipment. Careful selection and proper storage of visual distress equipment is important when boating with young children.

## **3.3.5 Registration Numbers**

Federal and state laws require a power boat to be registered in the state where it is primarily used. Registration numbers and validation stickers must be displayed according to regulations. The registration certificate must be on board when boating. The boat's serial number, required on the registration form, is found on the starboard side of transom and will always begin with the letters JBS. An accurate copy of it may be made using a pencil to stencil the outline on a piece of paper.

## **3.3.6 Lighting**

All Jones Brothers Marine boats are equipped with navigational lights that meet requirements for inland and international waters.

## **3.4 Additional Recommended Equipment**

In addition to the required safety equipment, the following tools, equipment and spare parts are recommended:

- Anchor and anchor line
- [7 to 5 way adapter plug](#) for the trailer
- Sea anchor
- Dock lines (4) and Spring Line
- Spotlight or flashlight
- Spare fuses
- First aid kit and Sunscreen
- Compass and navigational charts
- Hand operated bilge pump
- Extra keys
- Marine electronics

- Extra drain plug
- Oar or paddle
- Insect repellent
- Drinking water and food
- Spare propeller and hardware
- Bucket and sponge
- Tool kit including: adjustable wrench, slip-joint pliers, spark plug wrench and spark plugs, screwdrivers (slotted & Phillips), box end wrench set, hammer, roll of flexible wire, electrical tape, knife, prop nut, and hydraulic fluid. Keep tools and spare parts in good condition. Replace any parts removed from spare parts kit.

Use US Coast Guard approved or marine certified parts only.

Do not attempt any repairs or maintenance you do not understand or have proper tools to perform. Contact your Jones Brothers Marine dealer or another reputable service center.

### 3.5 Load Capacity

Though overloading is a primary cause of many boating accidents, improper loading is equally hazardous. Boaters should not only pay attention to the amount of weight, but also the distribution of weight in the boat.

	Overloading or improper weight distribution onboard can make your boat difficult to handle. Bad weather or rough seas could significantly reduce the stated capacity. Overloading is a violation of U.S. Coast Guard regulations.
---	---

#### Coast Guard Capacity Information Tag

Near the steering wheel, you will find a metal Coast Guard Capacity Information Tag indicating the maximum weight and person capacity for your boat. This tag will also designate the maximum horsepower limit for an outboard. You and your passengers will be in jeopardy and your warranty void if any of these stipulations are exceeded.

The capacity plate does not release the operator from the accountability of rational judgment. The boat's capacity can be reduced due to rough water and adverse conditions. Maintain a watch on weather conditions.

Example: Bateau 20 Capacity Plate

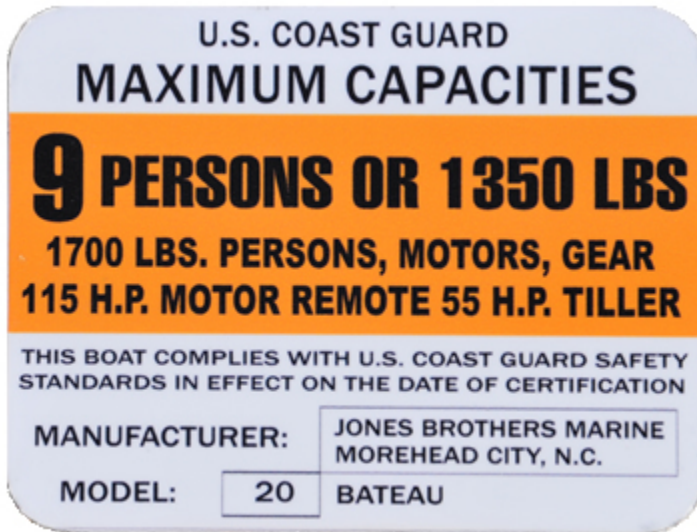

 <b>WARNING</b>	<p>Do not exceed your boat's capacity rating. An overpowered boat can become unstable, resulting in a loss of control or capsizing. An overloaded boat can become hard to handle. Overloading can also reduce freeboard and increase the danger of flooding or swamping, particularly in rough water.</p>
--	---

### Loading

When loading your boat remember to stay within the stated capacity and distribute the load evenly, keeping the load low to the deck. Always secure loose items so they don't shift or slide while you are on the water. When loading your boat always step onto the boat, never jump. Have someone on the dock pass any gear aboard.

Passengers should board the boat one at a time and find a seat. Passengers should remain seated during loading of the boat to maintain an even trim. Do not allow passengers to ride on the bow with feet hanging over the side, or allow passengers to ride sitting on the stern or gunwales.

### 3.6 Engine Safety Lanyard

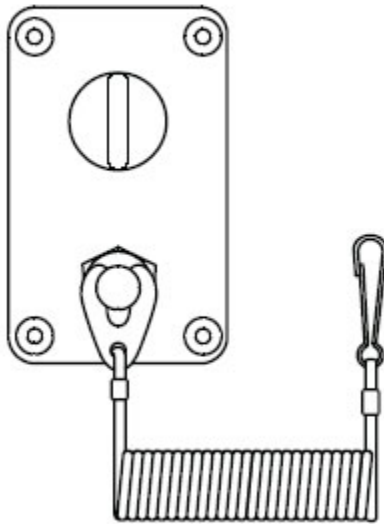

The engine will not run without the plastic clip on the **Engine Safety Lanyard** attached to the safety switch. The spring loaded safety switch is integrated with the ignition switch. If the clip is removed from the switch while the engine is running, the engine will shut down.

The lanyard can be attached to the boat operator during difficult or emergency sea conditions. If the operator moves away from the helm, the safety switch will kill the engine.

To reactivate the safety switch, attach the plastic clip to the switch to pull the post out from the kill position. The engine can then be restarted.

## 3.7 Weather

While local weather forecasts are generally accurate, it is always possible for the weather to change quickly. There is no substitute for personal observation and a good understanding of weather conditions. Weather and wave conditions can affect fuel consumption and travel plans - always prepare for the worst.

Note: Many marinas fly weather pennants. You should learn these since they can provide valuable information on changing weather conditions.

### 3.7.1 Storms

Thunderstorms can spring up at any time. Weather forecasts may often indicate the possibility of thunderstorm development.

Foul Weather Procedures:

1. Learn the basic cloud formations and watch the horizon for developing thunderstorms.
2. Keep a radio tuned to the local weather channel.
3. In the event of a storm, return to port if possible. If your boat is equipped with a poling platform, DO NOT stand on the platform using a pushpole if lightning has been sighted in your area.
4. Close portals and hatches and secure them. Stow all loose gear below deck and tie down any gear on deck.
5. Reduce speed and turn into the waves as the water gets rougher. Make sure everyone is wearing a Personal Flotation Device.
6. Put a sea anchor out. If you don't have one, use a canvas bucket or any object that will offer drag in the water.

### 3.7.2 Fog

The two types of fog you most likely will encounter are warm-surface or cold-surface fog. You can determine the chances of fog formation by periodically measuring air temperature and dew point temperature. If a slight variation develops between the two, expect the presence of fog.

Fog Procedures:

1. As fog sets in, take bearings and mark your position on a chart while continuing to log course and speed.
2. Make sure everyone is wearing a Personal Flotation Device.
3. If equipped with a depth sounder, compare readings against the soundings on your chart.
4. Post a lookout.
5. Reduce speed and periodically stop the engine to listen for fog signals from other vessels or structures.
6. Sound the proper fog signal for your vessel.
7. If in doubt about continuing on, anchor your vessel. Listen for other fog signals and continue to sound your signals at the proper interval and duration.

## 3.8 Emergency Conditions

Emergencies require immediate attention. The most important thing you can do during an emergency situation is to stay calm and use good judgment. Regularly review safety procedures and thoroughly check all safety equipment before going out on the water. Most serious situations can be lessened or avoided by proper prior planning.

### 3.8.1 Person Overboard

In most cases, a person falling overboard is a result of unsafe boating practices. Improper boarding or unsafe maneuvering can cause a person to fall overboard.

Should a person fall overboard, follow these procedures:

1. Turn the steering wheel to move the propeller away from the person. Keep an eye on the person and be prepared to toss a throwable flotation device with a line attached.
2. Circle around quickly, approaching into the wind and waves. Turn off the engine when the person is alongside the boat. Toss a throwable flotation device with a line attached to the person. Assist the person back into the boat.
3. Do not dive into the water after an unconscious person or a non-swimmer unless you are trained in lifesaving techniques. A panicky victim can drown his would-be rescuer. Make sure the rescue person is wearing a proper PFD before entering the water.

### 3.8.2 Capsizing

Hazardous conditions and/or improper operation of a boat can cause a boat to capsize or swamp. These conditions are usually unexpected and can happen quickly. Should your boat capsize, it is generally best to stay with the hull. Your boat has flotation which will keep at least part of the boat floating above the water line. Stay with your boat until help arrives.

**IMPORTANT:** Running a boat parallel to large waves greatly increase the chance of capsizing.

### 3.8.3 Fire

Fire aboard a vessel is one of the most serious and dangerous types of emergencies you can encounter. It is necessary to react quickly to get the fire under control.

1. Stop your boat immediately to prevent the risk of the fire spreading.
2. Have everyone put on their Personal Flotation Devices.
3. Attempt to put out the fire with an extinguisher by aiming at the base of the flames and using a sweeping motion.
4. If the fire continues out of control, use a distress signal and call for help on the radio. Everyone should then jump overboard and swim a safe distance upwind and up current of the burning vessel.

### 3.8.4 Collision

In the event of a serious collision, check everyone onboard for serious injuries, then inspect the boat for damage.

If your hull has a hole caused by another boat, be ready to plug it once the two boats are separated. A spare PFD or seat cushion makes a good plug for larger holes. While plugging the hole, reposition the weight on the boat opposite the hole. This will bring the hole nearer to the surface or even raise it above the water.

If the boat is in danger of sinking, have everyone put on their PFDs.

If your boat has a radio, call the U.S. Coast Guard or other rescue authorities (VHF channel 16 or 22 CB radio).

### 3.8.5 Running Aground

If your boat runs aground, check everyone for injury and then examine the boat for damage. Be sure to check the propeller. Many inland areas have rocks and stumps that could crack or puncture a fiberglass hull. Be familiar with the boating area. Caution should be taken in shallow water.

If you are lightly grounded, trim the engine up and try to shift weight of passengers/gear to heel the boat to one side while reversing engine.

If you are grounded on an incoming tide, you can wait until the tide is high enough to refloat your boat. However, if you are grounded on an outgoing tide, you should act quickly to refloat your boat.

	If you need to be <a href="#">towed</a> , DO NOT use deck hardware for towing. Use only bow or stern eyes. Jones Brothers Marine recommends using a commercial towing service if your boat becomes grounded or disabled.
---	--

## 3.9 Accident Reporting

Report all boating accidents to your local authorities. Federal regulations require boat operators that are involved in an accident to submit a written report within 48 hours. A written report must be filed if any of these conditions apply: a person disappears or dies within a 24 hour time span, requires medical attention and/or there is damage or a complete loss of property. When property damage exceeds \$500, the report must be submitted within 10 days. In the event of death or disappearance, notification is required immediately by phone or radio, in addition to the written report. These reports can be submitted to the State Boating Law Administrator. Forms can be obtained through USCG local harbor patrol offices, sheriff, and police stations.

## 3.10 Rendering Assistance

The owner or operator of a vessel is required by law to render all practical or necessary assistance to any person or vessel affected by collision, accident or casualty. However, you should not endanger your vessel or passengers to render assistance.



### 3.11 Boating Safety Tips

As a boat owner, you are responsible for the safety of both yourself and your passengers. It is your responsibility to know and follow all safety recommendations. Your boat and equipment should be kept in safe operating condition. Make a practice of regularly inspecting the hull, engine, safety equipment and all boating gear.

If you have a ship-to-shore radio telephone, always respond to distress calls. Note: The spoken word MAYDAY is the international signal of distress. MAYDAY should never be used unless there is a present danger (an emergency) and you are in need of immediate assistance.

The following precautions will add to you and your passengers' boating safety and pleasure:

- Before operating your Bateau, READ AND STUDY ALL OPERATION AND MAINTENANCE MANUALS. It is important that you fully understand how to operate your boat. If you have any questions, contact your Jones Brothers Marine dealer. Proper operation and upkeep will insure quality performance and longevity of your boat.
- A written float plan left with a RESPONSIBLE person can serve as valuable information in the event of a mishap and you do not return as scheduled. Upon returning, your primary responsibility is to notify the person of your return and cancel the float plan.
- Make sure required lifesaving and fire extinguishing equipment is onboard, clearly marked, accessible and in working condition. Instruct all passengers on the location and proper operation of safety equipment.
- Do not overload or improperly load your boat. The capacity plate should be used as a guide only. Common sense dictates that the capacity of your boat will be reduced by large waves or bad weather conditions.
- NEVER operate or allow anyone to operate your boat while under the influence of drugs or alcohol.
- Maximum care should be used when refueling your boat
- Know the fueling capacity and average fuel consumption at frequently used RPMs. Ensure sufficient fuel is onboard for anticipated cruising requirements. Keep an adequate reserve of fuel in case your plans change due to weather or other circumstances.
- Watch the weather and do not go out when there are storm warnings. If you are caught in a storm, reduce speed, head into the wind/waves, and keep all gear and passengers close to the center line of the boat for stability. Wear personal flotation devices and head for the nearest shelter.
- Instruct at least one passenger on the fundamentals of basic boating and safe operation in the event of an emergency.
- While boating, passengers should be settled in a safe position. Use handholds and rails for steadiness.
- Signs and signals for help are: raising and lowering your arms, waving a shirt tied to a pole, repeatedly sounding your horn, flying your boats ensign upside down, or the lighting of flares.
- Keep your boat speed under control. Respect for other boaters and those on shore is common courtesy. The operator of a boat is responsible for injury or damage caused

by the boat or the boat's wake (the wave the boat leaves behind). Your wake could swamp or damage a smaller craft and endanger its passengers. Stay alert to areas having signs posted "No Wake Zones."

- Become familiar with the handling personality and limitations of your boat.
- Never allow swimmers to enter or exit the boat with engines running. A shift lever in neutral could become engaged accidentally, causing serious harm to swimmers.
- When venturing into foreign waters, collect information on the boating area. Obtain a chart for new areas when possible.
- Clean water and air are responsibilities for all persons. Use litter containers on board and dispose of refuse properly. Know the local laws regarding the discharge of waste.
- Individuals under the age of 16 should not be allowed to operate the boat without adult supervision.
- Inexperienced drivers should have constant and direct supervision.

**GENERAL BOATING  
INFORMATION**

**Part**

---



**IV**

## 4 GENERAL BOATING INFORMATION

This part of the owners manual will cover topics related to a typical day on the water. First-time boat owners should take time to carefully read this section before launching your new boat.

Experienced boat owners may also want to take a quick tour - most of the information will be very familiar, but you may encounter something new. Also, if you notice anything missing that would be especially helpful to a new owner, please contact Jones Brothers Marine. We'd like to make this owners manual as helpful as possible.

### 4.1 Trailering

The adjustment and balance of your boat on the trailer determines how easily your boat may be transported. The tongue weight on the hitch ball should be 5-10% of the total weight of your boat, motor, and trailer. Tail-heavy loads cause swaying while trailering. The rollers and/or bunkers of your trailer should be adjusted so that the weight is distributed evenly across the stern and forward throughout the keel section. Your dealer should be responsible for adjusting your trailer properly.



Sway and fishtailing are especially dangerous at higher speeds where they can become uncontrollable.

#### 4.1.1 Trailer Checklist

- Coupler, hitch and hitch ball are of the same size
- Coupler and safety chains are safely secured to hitch or tow vehicle
- Check all fasteners for proper tightness
- Boat is securely tied down to trailer (Winch line is not a tie down)
- Wheel lug nuts are properly tightened
- Wheel bearings are properly adjusted and maintained
- Load is within maximum load carrying capacity
- Tires (including spare) are properly inflated
- All trailer lighting is working properly
- Trailer brakes are properly adjusted and working (If trailer is so equipped)
- Motor is in the recommended travel position
- Remove the boat cover - the canvas can be easily damaged during transit



Before towing the trailer, be sure to read and familiarize yourself with the instructions and warnings supplied with it. Also, always be familiar with and comply with the vehicle towing capacity and requirements of your vehicle.

### 4.1.2 Disc Brakes and the Reverse Lockout

The trailers used for the Bateau often have brakes installed. Almost all trailers with brakes are now delivered with disc brakes installed, and disc brake systems automatically activate when the trailer goes in reverse. **To backup the trailer, the disc brakes must be disabled to allow the trailer to be moved in reverse.** There are two ways to disable the disc brakes for backing up the trailer:

#### **Use a 7 to 5 way adapter plug**

Many vehicles come factory equipped with tow packages and most have a 7 connector round plug. After verifying that the center pole in the round plug is the back up light circuit, the easiest solution is to buy a 7 to 5 way adapter plug that will plug into the tow vehicle and mate with the trailer harness.



When you put the tow vehicle in reverse, the power that illuminates the vehicle's backup lights also applies power to the reversing solenoid valve. The valve will close and block additional fluid pressure in the braking system allowing you to back up. **DO NOT BE HASTY.** Be aware that in any surge system there is residual pressure on the brakes when backing up an incline. Reverse lock out does not release this pressure. Also, if you have just come to a hard stop, pull ahead slightly to relieve pressure on your brakes before putting tow vehicle in reverse.

**Where to Buy** - The 7 to 5 way adapter plugs can often be found in the automotive section at **Walmart**. They can also be purchased from many online stores that carry trailer components. Note: Most of the adapters sold in stores are 7 to 4 way plugs - be careful to

select the appropriate plug for the wiring connector on the trailer. If you have any questions, please contact your Jones Brothers Marine dealer.

At the time of this writing, the following links can be used to purchase adapter plugs:

<http://www.shipstore.com>

<http://www.northerntool.com>

<http://www.rvpartscenter.com>

### **Use the Locking Pin**

If a standard 4 way connector is plugged into the 5-way connector on the trailer, then putting the vehicle in reverse will not power the unused reversing solenoid pin on the trailer connector. In this case, the steel locking pin normally used to lock the coupler onto the ball can be moved to manually lock the brake lever mechanism on the coupler.



## 4.2 Driving

Do not allow passengers to ride in the boat while trailering. Check the brakes prior to leaving. Drive as smoothly as possible and try to avoid sudden jerks. Anticipate sudden stops, and make wide turns. Road trips require occasional stops to make sure the trailer is still secured properly. Also, periodically check the wheel bearings by touching the hubs. If a hub is hot, the bearing is starting to fail.

If you are a new boat owner with little trailering experience, do not drive from the dealership to a boat ramp - especially on a holiday weekend! Maneuvering a boat trailer requires some practice. Take your boat to an open area and get accustomed to backing the trailer before attempting to launch in a confined marina. The trailer always backs in the opposite direction of the vehicle. To maneuver the trailer, turn the steering wheel in the direction you want the trailer to go.

## 4.3 Fueling

**Safety during fueling requires CAUTION and COMMON SENSE.** Please study the following precautions carefully, and ask your dealer if you have questions.



Never let the odor of gasoline go unchecked. Fuel leakage can cause fire and explosion.

### 4.3.1 Preliminary Procedures

**IMPORTANT:** Do Not use fuels that have added alcohol or alcohol derivatives. Alcohol causes marine fuel system hoses and components to deteriorate.

- Safely moor your boat to the dock.
- Turn OFF all electrical equipment and the engine.
- Extinguish all flames or smoking materials.
- Close all ports, hatches, windows, and engine compartments, to prevent fumes from accumulating in closed areas.
- Ensure a fire extinguisher is close by.
- Observe all safety regulations for the safe handling of fuel.



Fuel vapors are explosive and can become trapped within the lower portions of the boat. All hatches, windows, doors, and compartments must be closed when fueling your boat.

### 4.3.2 Fueling Procedures

- Check your engine owners manual to confirm the type of fuel specified by the manufacturer. In most cases, the engine will require mid-grade.
- Always fuel in good lighting. Gasoline spills may not be noticed in poor lighting or in darkness.
- Keep the fuel supply nozzle in contact with the fuel tank opening to prevent any static sparks.

- After pumping approximately 10 gallons of fuel into the fuel tank, inspect the engine and fuel tank area for any signs of fuel leakage. Continue fueling if you do not detect leakage or other problems.
- Watch fuel flow constantly to prevent overflow or spills.
- Allow space at the top of the tank for thermal expansion. NOTE: An over-filled fuel tank will leak fuel from vents, causing damage to the finish of your boat.
- If fuel appears to be entering fuel tank very slowly, check for fuel vent blockage or kink in the fuel line.
- If you operate an outboard with an oil injection system, check the engine manual for the approved type of oil and fill the tank completely.



Do not overflow the fuel tank or allow fuel spills into the hull or bilges. Visually monitor fuel vent, which is part of the fuel fill fitting. Do not fill tank to the point that fuel comes out of the vent.

### 4.3.3 Fuel Capacity

Refer to the Bateau specification sheet, brochure, or check with your Jones Brothers Marine dealer for fuel capacity of your particular Bateau model.

### 4.3.4 After Fueling Procedure

- When you have finished fueling, close the fuel fill and wipe up any spills in the fuel fill area. Dispose of rags or sponges used for clean-up - DO NOT store these items on board.
- Open engine compartment and all hatches, windows and doors closed during fueling. Inspect these areas for fuel fumes or fuel line leakage. Any sign of fuel leakage, must be investigated and corrected before starting the engine.
- Inspect the fuel lines and connections for tightness, signs of leaks, and deterioration. Annually, conduct a more precise inspection of fuel system components, especially those hidden from routine inspection. Replace any deteriorated hose, clamps, connections, or fittings.

## 4.4 Launching

Prior to initial launch, familiarize yourself with this manual and all aspects of your boat. At the launch site, go through a prelaunch checklist. The list should be suited to your specific needs, but the following items should be included:

- Make sure the drain plug is tightly in place
- Attach the launch ropes to the bow and stern
- Make sure the proper safety equipment is on board
- Tilt the engine or drive unit to the "up" position
- Remove the tie down strap



- Be sure you have enough fuel to get to a fueling dock

After the pre-launch check, back your trailer slowly into the water, preferably keeping the axle hubs above water (unless your trailer is a submersible model). Set the emergency brake on your vehicle and place chocks under the rear wheels. Attach a bow line to the boat, release the winch cable, and give the boat a firm push. When the boat is clear of the trailer and secured to the dock, move the trailer to the parking area.

## 4.5 Pre-Start Checklist

- Check the bilge for excess water and leaks
- Turn on the bilge pump to remove any excess water, and leave the pump on stand-by
- Check the engine oil level, battery cable connections and electrolyte level
- Check the steering for freedom of movement
- Make sure the navigation lights are in working order

## 4.6 Starting

- **Note: The [Engine Safety Lanyard](#) must be attached to the starter switch to allow the engine to start.**
- Use the engine trim switch on the throttle lever to lower the engine to the "down" position. Be sure the propeller is free of any obstruction.
- Set the control lever in the neutral position.
- Pump the in-line fuel primer bulb to remove air from the fuel line. Stop squeezing the primer bulb when it feels full of fuel.
- Turn the ignition key to start while simultaneously pushing on the key to engage the choke.
- If the engine starts but will not idle - Immediately after the engine catches, push the rubber button on throttle pivot and then push the lever forward. This leaves the engine in neutral but provides additional fuel. Do not over-rev the engine
- After starting, check all instruments. If the oil pressure gauge does not respond immediately, shut off the engine.
- The engine is water cooled. Look for a small stream of water being sprayed from the starboard side of the engine. Shutdown the engine if no water is being sprayed.
- Test steering and throttle response at the dock.

## 4.7 Docking and Leaving the Dock

**Note:** In a marina or any congested environment, use very little throttle and move the boat **SLOWLY!** Also, make sure all passengers keep their hands inside the boat.

Slowing and stopping your boat requires practice. The length of time required to come to a complete stop will vary with wind and current. Judging the distance between the boat and dock while considering the momentum of your craft is a skill that greatly improves with experience and practice.

Unlike an automobile, the stern of your boat reacts first when turning. A turn to the right will swing the stern to the left and vice-versa. Remember that turning your boat away from an object, such as a dock, will tend to swing the stern toward that object.

### Docking

Before bringing your boat to the dock, consider the wind and how it may be used to your advantage. Your boat is more maneuverable against the wind than with the wind.

Slowly approach the dock at a 30 to 45 degree angle. Before the bow reaches the dock, shift the engine to neutral, turn the steering wheel toward the dock, and shift the engine into reverse. As the boat slows the stern will swing toward the dock.

### Leaving

When pulling away from the dock, push the stern clear of the dock to make sure you have enough room to maneuver. You can get underway without bumping the stern against the dock. Care should be taken when fending off with your arms and legs; they could become crushed between the boat and the dock.

## 4.8 General Information on Boat Handling

The best method of learning how to handle your Bateau is to practice and experiment. Even experienced boat owners need to learn a new boat's characteristics.

Practice and experiment away from congested areas. For slow speed maneuvers, find a mooring buoy or pole to work with. Approach the object at different speeds, and work with the wind and tide to find out how they affect your maneuvers.

Try to get a feel for the following:

- Minimum speed for effective steering.
- Turning radius at different speeds.
- Response to steering at low speeds.
- Accelerating and deceleration rates.
- Time and distance to bring the boat to a stop at different speeds.

- Try to get an idea of your fuel consumption at various throttle settings and load conditions. The engine owner's manual will have guidelines, but you should develop a feel for your fuel usage. Never completely trust your gas gauge!

## 4.9 Towing or Being Towed

In the event of a mishap or power loss, you may need to tow a boat or be towed. You should not tow a boat larger than your own. Never tow a boat if you are not equipped with the proper lines. Nylon ropes are recommended due to the strength and elasticity they provide to absorb the shock of towing that may occur. Passengers should never grasp a towline, it should be secured to the boat.

Before towing a boat, make a bridle and tie it securely to the pad eyes on the transom with enough slack to clear the engine and stern drive. Attach a tow line to the bridle so that it may slide from side to side, to prevent too much pressure on a single pad eye. The tow line should then be attached to the bow eye or a bridle on the towed boat. The tow line should be a minimum of twice the length of the towing boat, the longer the better.

When passing a towline to the other boat, do not try to run in too close. Send a light line or attach the towline to a life preserver to be collected. Be careful of the other boat's propeller.

**Note: If the situation on the water requires an immediate tow and you do not have time to make a bridle, loop the tow rope three times through a pad eye on the transom. Then use the closest cleat on the stern to attach the line. Pad the line with a towel or cushion to prevent chafing. The towed boat can do the same thing using the eye on the bow.**

The towed boat should keep someone at the wheel, to prevent the boat from straying off course. Start the tow off slowly. A steady pull at a moderate speed should be used during tow. Watch the action of the towing boat. If too much slack develops in the towline and contact is imminent, turn in either direction to avoid hitting the stern.



As a precaution, passengers on both boats, should stay clear of the towline. The line can snap and fly in either direction causing injury.

## 4.10 Anchoring

Some factors that determine the size and type of anchor most suitable for your boat include the size of your boat and the type of lake, sea, or river bottom in your boating.

The length of the anchor line should be at least 4 to 7 times the depth of the water. Increase this length in strong winds and currents. A 3 to 4 foot length of chain between the anchor and the anchor line will help prevent the line from chafing on rough obstacles, and will also help hold anchor flukes down for more secure anchoring.

To anchor, pilot the boat into the wind or current to stop the forward motion. Make sure your anchor line is secured to a cleat. Lower the anchor into the water until it reaches the bottom. Feed out the anchor line slowly as the wind or current forces the boat backward. Reverse engine(s) if necessary. To make sure anchor is set, take a gradual strain off the rode then pull firmly before stopping the engine.

Even while anchored, your boat will swing with the wind, so do not anchor close to other boats or objects. Furthermore, it is illegal to tie your boat to navigational aids, such as buoys and markers.

To retrieve the anchor, slowly drive the boat to the point directly above the anchor and pull upward on the anchor line until anchor is retrieved. If the anchor is difficult to break out, tie off the anchor line while directly over the anchor and slowly motor forward to "break" the anchor free.

**Note: If you plan on anchoring in a congested area, make sure you have another small anchor onboard. In North Carolina on holiday weekends, you'll see boats drop the main anchor in deep water and then back toward the beach. The small anchor is thrown to hold the stern near the beach and prevent the boat from pivoting. The anchor lines are played in and/or out to adjust for tides and unloading/loading of passengers and gear.**



Never anchor off the stern of the boat, especially in strong winds or currents. The weight of the stern and flat surface to the seas can easily cause water to enter over the transom, and swamp the boat.

## 4.11 Recovery

- Secure the boat to the dock or boarding platform.
- Clear equipment and passengers from the boat.
- Back the trailer into position --- (reference Launching).
- Use the bow line to maneuver the boat into position for loading.
- Load and secure the boat onto the trailer.
- Move the trailer and boat away from the ramp and remove the drain plug to allow water to drain from the boat.
- Complete cleanup and other safety measures before trailering.

## 4.12 Daily Cleanup and Storage

Before storing your boat after a day on the water, do your daily cleanup. A little effort will go a long way in keeping your boat in good working order, and will allow you to get on the water quickly for your next trip.

- Remove gear and fishing tackle that doesn't stay onboard
- Get rid of trash and especially bait or chum
- Use fresh water to hose off the boat, engine and trailer
- If you have time, do a quick wash on the boat using soapy water
- Attach the hose to the engine and flush the motor with fresh water
- Remove the drain plug to allow the bilge to drain and dry

- If you store your boat near the ramp, you may want to refuel before storing your boat. If you have a long drive while trailering your boat, you might want to wait until the next trip to refuel.
- After storing the boat, lower the engine and turn off the batteries if your boat is equipped with a battery switch.



**OPERATION**

**Part**

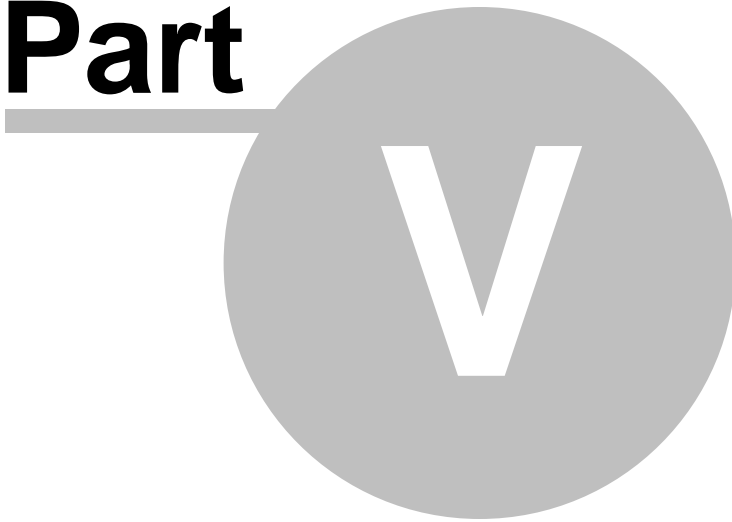

## 5 OPERATION

This part of the owners manual will cover topics related to the operation of the boat. First-time boat owners should take time to carefully read this section before launching your new boat.

Experienced boat owners may also want to take a quick tour - most of the information will be very familiar, but you may encounter something new. Also, if you notice anything missing that would be especially helpful to a new owner, please contact Jones Brothers Marine. We'd like to make this owners manual as helpful as possible.

### 5.1 Performance

Maximum performance is dependent on many factors and cannot be guaranteed. These factors will vary with altering conditions. Some of these factors are:

#### **ENGINE EFFICIENCY**

Assuming your boat is equipped with the correct engine, the engine is properly tuned, and the drive system is in good condition, engine(s) operate most efficiently at the RPM stated in the engine manual. Efficiency will decrease if normal care and maintenance are not performed. If engine(s) are neglected, power will drop and speed will decrease. In addition, expensive repairs may become necessary. Be sure to follow all instructions in the engines' Operation Manual.

#### **WEATHER CONDITIONS**

Weather conditions influence engine performance. Barometric pressure and humidity also affect horsepower.

#### **LOAD DISTRIBUTION**

A decrease in performance will be noted when gear, equipment, passengers, and fuel are added. This extra load will affect the performance of your boat according to the distribution of the weight.

Other types of extra load could be water in the bilge. A gallon of water weighs 8 pounds. When water accumulates in the bilge, performance will be affected. Keep the bilge dry to eliminate this type of extra load.

#### **MARINE GROWTH**

Maximum performance is only obtained when your hull bottom is clean. Growth on the bottom of the boat will increase resistance and decrease speed. This will also increase fuel consumption.

### 5.2 Engine

Details concerning the engine is located in the Operation and Maintenance manual supplied by the engine manufacturer. Your familiarization with the engine reference material will result in the proper maintenance and operation that is essential to ensure safe and enduring engine performance. The manual is in the boat package with the other literature.





Acceleration at FULL throttle is not recommended before the engine break-in period has been completed, and the first engine check-up performed. For information about the break-in period, please examine the engine owner's manual. FULL throttle acceleration should not take place until after this check-up.

## 5.3 Propeller

The condition of your propeller (prop) has a major influence on the performance of your boat. Your engine is equipped with the best size prop for normal conditions. If you have unusual use or weight conditions, a special prop may be required for altered applications. Also, it is advisable to keep an extra prop on board. A damaged prop can affect your boat's top speed, cause vibrations or a sudden drop in RPMs, or increase fuel consumption.



When replacing propellers, stay within the engine manufacturer's maximum and minimum RPM ranges. This information is in your engine manual.

### Troubleshooting:

**Cavitation** occurs in all propeller driven boats under certain conditions. It is easily recognized by sudden increases in RPMs (rewing) or a sudden drop in speed. This occurs when cavities or air pockets form around the prop, due to improper size or damage to the propeller. Cavitation is influenced by prop design, speed, placement, and even water temperature.

**Ventilation**, a similar problem, caused by air drawn in around the prop in a tight turn or improper engine trim angle. In most cases, a change in the drive angle will correct the problem. If either of these problems persist, you are advised to experiment with a different size prop or contact your dealer.

## 5.4 Trim

The engines on all Bateau models are equipped with power tilt and trim mechanisms. The purpose of the tilt is to raise the engine for launching, loading, or trailering your boat.

Trim refers both to the weight distributions inside the boat and to the angle of thrust of the drive unit. The angle of thrust from the engine either forces the bow up or down. An engine tilted too far in (forward) will cause the bow to nose downward or "plow." A drive unit tilted too far out (aft) will cause the bow to ride too high. Adjust the trim so that the angle of thrust is parallel to the water at full throttle at a normal running attitude.

When the angle of thrust is too far out (aft), the engine noise may rise indicating that the propeller is cavitating. Adjust the engine trim in (forward) to correct the problem. The boat may also tend to "porpoise" or oscillate in maximum bow up position as well. This can be corrected by adjusting the engine trim in to lower the bow.

For a smoother ride when running into heavy seas, the bow should be adjusted so that the entry point into the water is slightly forward of the helm location. When running in a following sea, the bow should be trimmed higher to prevent the boat from plowing into the seas. As sea

conditions change, experiment with the trim to find the best performance for your particular boat and load.

## 5.5 Trim Tabs

The Bateau can be optionally equipped with Lenco electric trim tabs. These units offer the best performance and speed of any adjustable tabs on the market.

**Note: It is recommended that you familiarize yourself with the operating characteristics of the boat at all power settings before utilizing the trim tabs.**

The trim tabs are operated by a two rocker switch panel. The rocker switches are marked *bow down* and *bow up*. The *bow down* adjustments can be made to progressively deploy the trim tabs. The extreme *bow up* positions will fully retract the trim tabs, and the tabs will have no effect on the boat's ride.

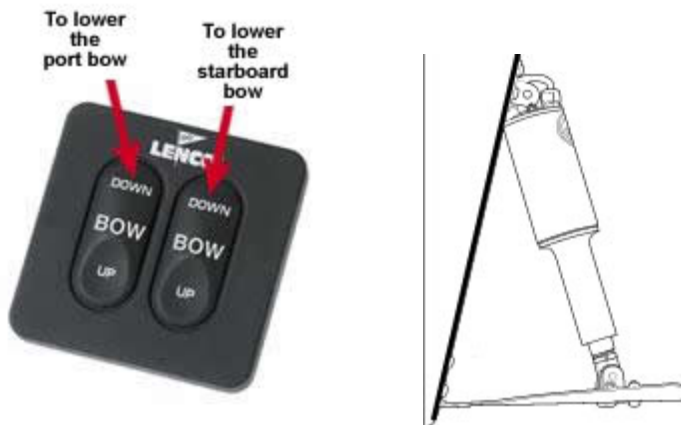

Trim tabs are truly wonderful and allow you to get the maximum performance from your boat. They also allow the operator to compensate for varying sea conditions to provide the driest, safest ride possible.

### Quick Planing

When both tabs are lowered (*bow down*) a boat can get on plane quickly by adding lift to the stern.

### Lateral Trim

On the Bateau, the tabs are often used to maintain lateral trim. If your boat heels to one side because the passengers have changed positions, the tabs can be used to compensate by adding lift to one side.

### Staying Dry

Trim tabs are also useful in adjusting the attitude of the boat in undesirable sea conditions. For example, you can raise the bow on one side of the boat to give you and your passengers more protection when heading into quartering seas.

### Porpoising

Engine trim is often used to optimize the attitude of the boat for fuel efficiency. If sea conditions cause occasional bow oscillation (porpoising - or an up and down movement of the bow), both tabs can be slightly lowered to provide a smoother ride.

Note: Trim tab adjustments are normally used to compensate for specific sea or load distribution conditions. Make sure you remove the adjustments as soon as those conditions change.

Trim tabs are high-performance accessories. It is necessary for the operator to practice and learn the trim characteristics and response times of the trim components of the boat.

## 5.6 Throttle/Shift Control

The throttle/shift control on the console controls the flow of fuel to the engine and acts as a gear shift lever to control the forward and aft thrust of the propeller.

The vertical or middle position of the throttle control is the neutral position. Move the control forward to engage the shifting mechanism, which creates a forward thrust of the propeller. Advance the forward movement to increase the fuel flow to the engine and boost the forward lunge.

Move the control lever aft of the neutral position to reverse the shift mechanism and create a reverse thrust of the propeller. Increase the aft movement to increase the reverse thrust. Remember that propellers are designed for maximum forward thrust, so reverse thrust will not be as efficient.

The throttle/shift control has a safety mechanism which will not allow the engine to start when the control is in gear. To increase the flow of fuel to the engine while remaining in the neutral position, you may use the neutral lock out button in the control handle.

As the boat is moving forward, you may reverse the shift mechanism that will provide a "braking action," slowing the boat.

 <b>CAUTION</b>	This braking action causes a following wake which may rise above the transom and flood the boat if it is moving at too great a speed. Allow engine RPMs to decrease before shifting into reverse.
--	---

The throttle/shift control should be cleaned and kept free of corrosion. Periodically check for:

- loose mounting screws
- check the cable conduit for cracks, abrasions, kinked or bent cable, (see your dealer to replace damaged cable)
- check the cable ends and cable fittings for corrosion
- loose brackets
- worn or damaged fittings

Replace any necessary parts. Cable ends, fittings, and the control mechanism may be sprayed with a moisture displacing lubricant. If your throttle or shift cables need replacing, please contact your Jones Brothers Marine dealer or another reputable service center for repairs.

**CAUTION**

When shifting between forward and reverse, always pause in NEUTRAL for a few seconds before reversing the rotation of the propellers. This will prevent unnecessary wear to the drive system.

**WARNING**

High speed acceleration in reverse creates a wake that could wash over the transom and enter the boat.

## 5.7 Steering

Hydraulic steering systems require regular preventative maintenance for safe and reliable operation. The oil level in helm pump must be maintained within acceptable operating levels. A low oil level will cause air to be introduced into the steering system and result in unresponsive steering. The oil level should always be within 1/2 inch from the base of the fill hole, located on the front top portion of the helm pump. Check steering system for oil leaks. Unobserved leaks, in time, will result in unresponsive and/or possible loss of steering.

All moving mechanical linkages, sliders, etc. must be greased as needed with a high quality marine grease. Refer to the steering manual for specific recommendations and additional maintenance requirements.

Any slow or sudden change in the "feel" of your steering system indicates an immediate need for a thorough inspection. All repairs and replacements to steering systems should be made only by an authorized dealer.

## 5.8 Switch Panel



The switch panel is located on the console and has six toggle switches. In the picture on the left, all switches are in the OFF position - the lights switch is in the middle position and the remaining switches are thrown to the right.

**LIGHTS NAV/ANC** - This three position switch (NAV-OFF-ANC) changes the lighting configurations to running or anchor lights.

**BILGE PUMP** - Your boat is equipped with an automatic float switch on the bilge pump which is wired directly to the battery. The bilge pump automatically activates when a significant amount of water accumulates in the bilge. The two-way switch on the switch panel serves as a manual override if the float switch on the bilge pump fails.

**LIVEWELL** - This switch activates the optional livewell system.

**WASHDOWN** - This switch activates the optional washdown system.

**ACCESSORY** - There are two accessory switches that can be used to switch optional electronics. A VHF radio, fish and depth finders, and GPS systems can be controlled by the accessory switches. Contact your dealer if you have questions about how these switches are used on your boat.

## 5.9 Fuse Panel

The Bateau has a ten position fuse panel located inside the console. The panel uses automotive type fuses.

The picture below shows the first six positions used by the switch panel. The remaining positions can be used by optional electrical equipment. Please contact your dealer for additional information about the fuse panel.

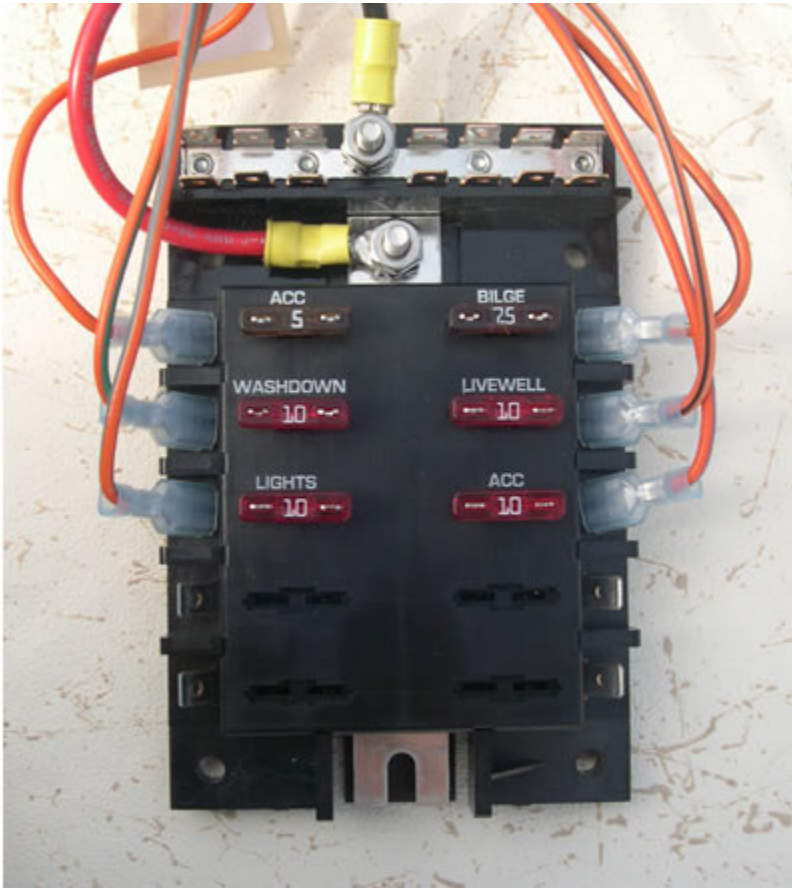

## 5.10 Single Engine, One Battery with a Cut-Off Switch

The Bateau single battery configuration usually has a battery cut off switch installed - most storage facilities now require the battery cut off. The switch is mounted with the battery inside the console.



## Wiring Diagram

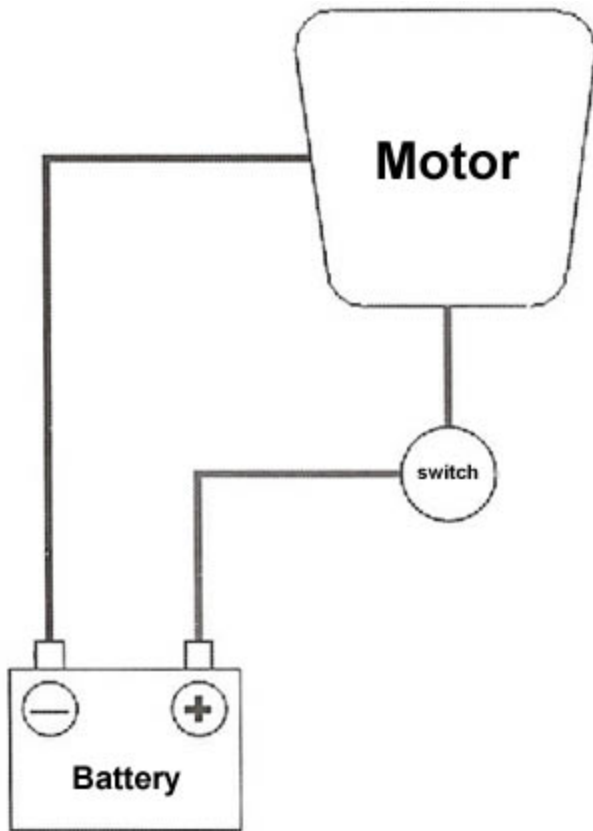

### 5.11 Single Engine, Two Batteries and one Dual Battery Switch

The Bateau dual-battery configuration option uses a Dual Battery Switch. The switch is mounted with the batteries inside the console. Since most customers order this option to have a reliable backup starting battery, it is important that the switch be used properly (position #1) to insure both batteries maintain a suitable charge.

**Yamaha Battery Isolator Charging System** - Jones Brothers wires the dual-battery configuration with the optional *Yamaha Battery Isolator Charging System*. This prevents draining the cranking battery (#1) by electrical accessories which run off of battery #2. The isolator system allows for the simultaneous charging of the engine cranking battery and an accessory battery even when the battery switch is in the default #1 position. Once the engine is started, the battery with the lowest charge potential will receive the majority of the charging system output. When the batteries are brought up to the same charge potential, both batteries receive equal charge output.

#### **STORAGE**

When storing your boat, always turn the switch to the **OFF** position. If an electrical device was left on, this prevents accidental discharge of the accessories battery (#2).



**STARTING**

Under normal operation, select the cranking battery **#1** to start the engine. If the engine fails to start, switch to the accessories battery (**#2**) and try again. **BOTH** or **1+2** should only be tried if the batteries are discharged to a point where neither alone can provide enough current to crank the starter motor, but combined in parallel they can turn the engine over.

**RUNNING**

With the Battery Isolator system, both batteries will charge with the switch set to battery **#1**. If you had to crank the motor using the accessories battery (**#2**) or **BOTH**, try switching back to the cranking battery (**#1**) after running the engine for a few minutes.

**An explanation of each switch position:**

In the **OFF** position, the two batteries are disconnected from all loads. The OFF position is used when the boat is being stored or otherwise not in use. It prevents any drain from the batteries. This can be useful if a circuit has been accidentally left on, say a cabin lighting circuit or similar drain. Such a load can completely discharge a battery in a day or two, leading to an unanticipated dead battery situation when you return to your boat.

In the **1** position, battery #1 is only used for cranking and battery #2 runs the accessories. Both batteries are charged simultaneously - the cranking battery through the positive battery cable and the accessory battery through the battery isolator charging wire.

In the **2** position, all loads and charging currents are connected to accessories battery #2. Now it supplies current required by starting and running, and it receives all the charging current from the engine. The Cranking battery #1 is totally isolated.

In the **BOTH** position, the two batteries are connected in parallel. This has a number of implications. Unless the batteries have exactly the same state of charge, the combined voltage to the two batteries in parallel will sag to a voltage somewhat lower than the highest battery's terminal voltage. Current from the higher voltage battery will flow into the lower voltage battery and begin charging it. As long as the state of charge in one battery is higher than the other, the lower battery is more of a load than a source of power. Eventually, the batteries will reach an equilibrium, and they will both have the same terminal voltage. At that

point they will both tend to supply current to loads that are attached to them, and they will both receive charging current furnished by the engine.

It would seem like operating in the BOTH position would be beneficial, but that is not always the case. Even though the batteries will eventually rise or fall to the same terminal voltage when connected together, they will not necessarily become exactly the same. To describe the situation in the simplest of terms, when two batteries are connected in parallel, they will probably tend to behave more like the weakest battery of the two than the strongest.

Paralleling the batteries can come in handy in some situations. For example, both batteries may be discharged to a point where neither alone can provide enough current to crank the starter motor, but combined in parallel they can turn the engine over.

If one battery is fully charged and the other is totally discharged or damaged, connecting them in parallel (by using the BOTH position) can cause very high currents to flow between the batteries. Extreme heat can be generated by the sudden charging of the discharged battery. Use caution in this situation. It is better to recondition a discharged battery by slowly re-charging it with an AC-operated battery charger.

The arrangement of the contacts of the typical OFF-1-2-BOTH permits the operation of the switch in the range of 1-2-BOTH without ever disconnecting the batteries from the load or the outboard charging circuit. This is important, as it is possible to cause damage to the charging circuit if the battery is disconnected while the engine is running. By choosing the path of rotation of the switch, it is possible to change from 1 to 2 without moving through the OFF position. Note: The Make-Before-Break feature on the switch allows switching between 1-ALL-2 positions with running engines.

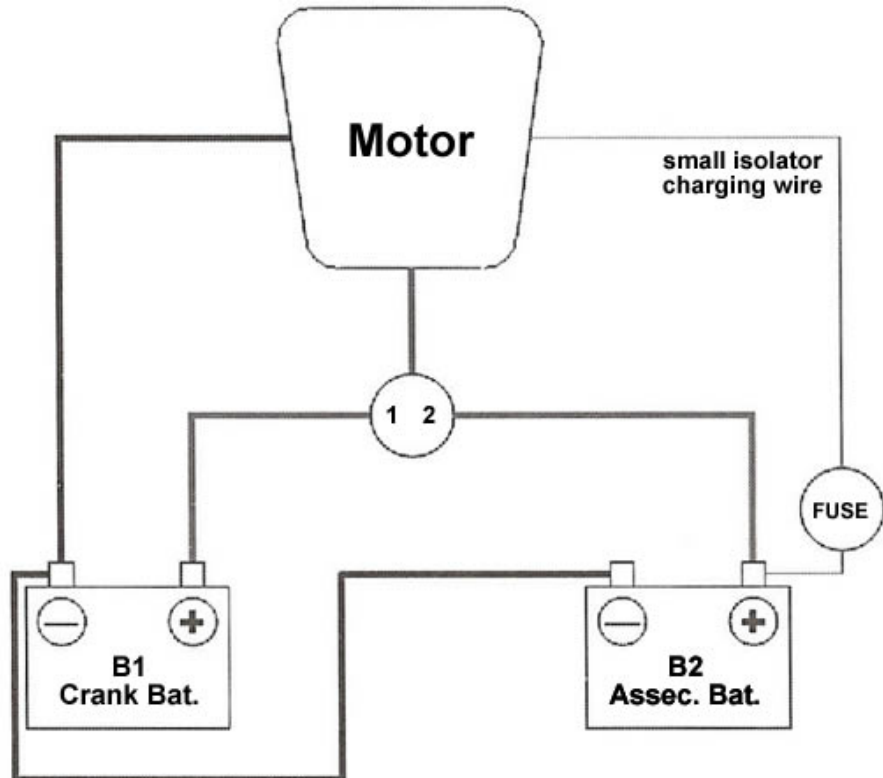
**Wiring Diagram - Single engine with two batteries using an Isolator Charging Circuit****CAUTION**

Always STOP engines before switching to "OFF" position.

Erratic operation, particularly after a very long periods of idleness, can be cleared by rapidly switching back and forth briskly several times without any load connected.

NOTE: If switch is to be mounted in an area subject to corrosion, it is recommended that a liquid electrical coating be applied to the terminal connections.

## 5.12 House Switch

Boats configured with the Dual Battery option will also have an additional switch for the accessories, and is typically mounted to the right of the Dual Battery switch. This is usually called the “house” circuit by the marine industry. Turn on the house switch to activate the electronics and other accessories on the boat. Note: The house switch does not control engine functions or disable the automatic float switch on the bilge pump.



## 5.13 Bilge Pump Wiring

Your boat is equipped with an automatic float switch on the bilge pump. The float switch is attached with a fused connection to the positive terminal of the battery. In a dual battery configuration, the switch is connected to the accessories battery (#2). The bilge pump automatically activates when a significant amount of water accumulates in the bilge. The two-way switch on the [switch panel](#) serves as a manual override if the float switch on the bilge pump fails.

Note: The battery cut off switch disables the manual bilge switch on the switch panel. However, since the automatic float switch on the bilge pump is wired directly to the battery, the bilge pump can operate even with the cut off switch in the off position.

## 5.14 Rod Storage

The Bateau 20 and 23 have rod storage under the gunwales - two rod racks on each side of the boat.



Care should be taken when rods are stored in the lower rod racks. These rods will be much more exposed to accidents than rods placed in the upper storage rackssss.

## 5.15 Plugs and Through Hull

The diagram below shows the location and type of plugs used on the Bateau.

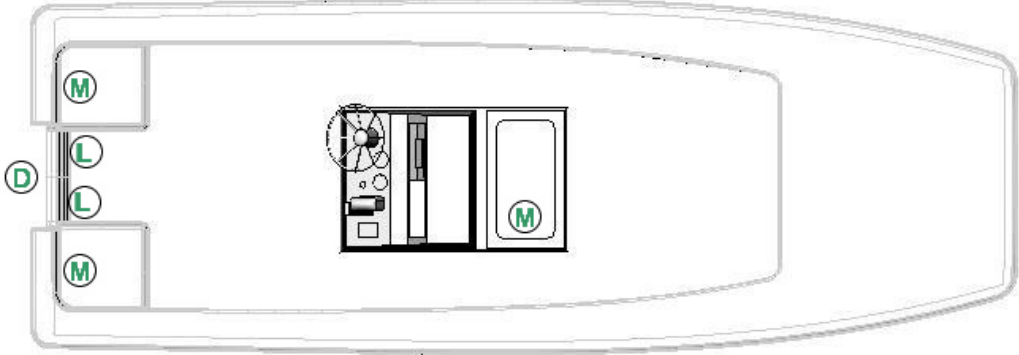

**Drain Plug**

**D**



3/4" Stainless Steel Drain Plug

**Large Plug**

**L**

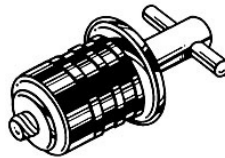

1 1/4" Brass Turn-Tite

**Medium Plug**

**M**



1" Brass Snap-Tite

Note: If the plug is too loose, tighten the nut several times to adjust.

## 5.16 Livewell

The Bateau can be optionally equipped with a livewell. Jones Brothers Marine recommends that the livewell be installed by the factory, or qualified marine mechanic.

**Filling the Livewell** - To fill the livewell, plug the drain at the bottom of the livewell tank, and then open the seacock located in the bilge. Activate the livewell switch on the console. The livewell pump will then fill with water through the intake fitting near the bottom of the box. The water level will rise to a point slightly below the top of the livewell and will then drain through a screened overflow.

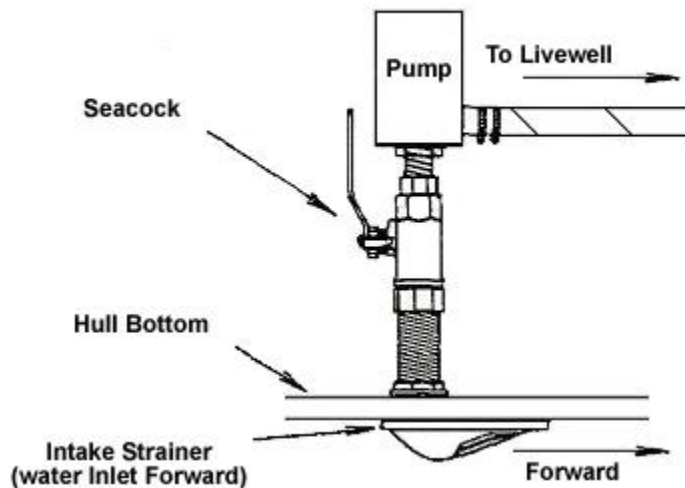

Note: If the seacock is left open, the forward motion of the boat can gradually fill the livewell tank even when the livewell pump is not turned on.

**Empty the Livewell** - To empty the livewell, stop the boat and turn off the console livewell switch. Close the seacock, and then unplug the drain on the bottom of the livewell. After the livewell drains the plug can be returned to the drain to provide dry storage.

## 5.17 Washdown Faucet

The Bateau can be optionally equipped with a washdown system. Jones Brothers Marine recommends that the system be installed by the factory, or qualified marine mechanic.

To operate the washdown faucet, open the seacock located in the bilge. Activate the washdown switch on the console to pressurize the washdown faucet. The washdown pump has internal pressure switch which maintains water pressure until the system is switched off.

After the washdown system is pressurized, the hose and spray nozzle can be used as needed. When finished, turn off the washdown switch on the console and then close the seacock.

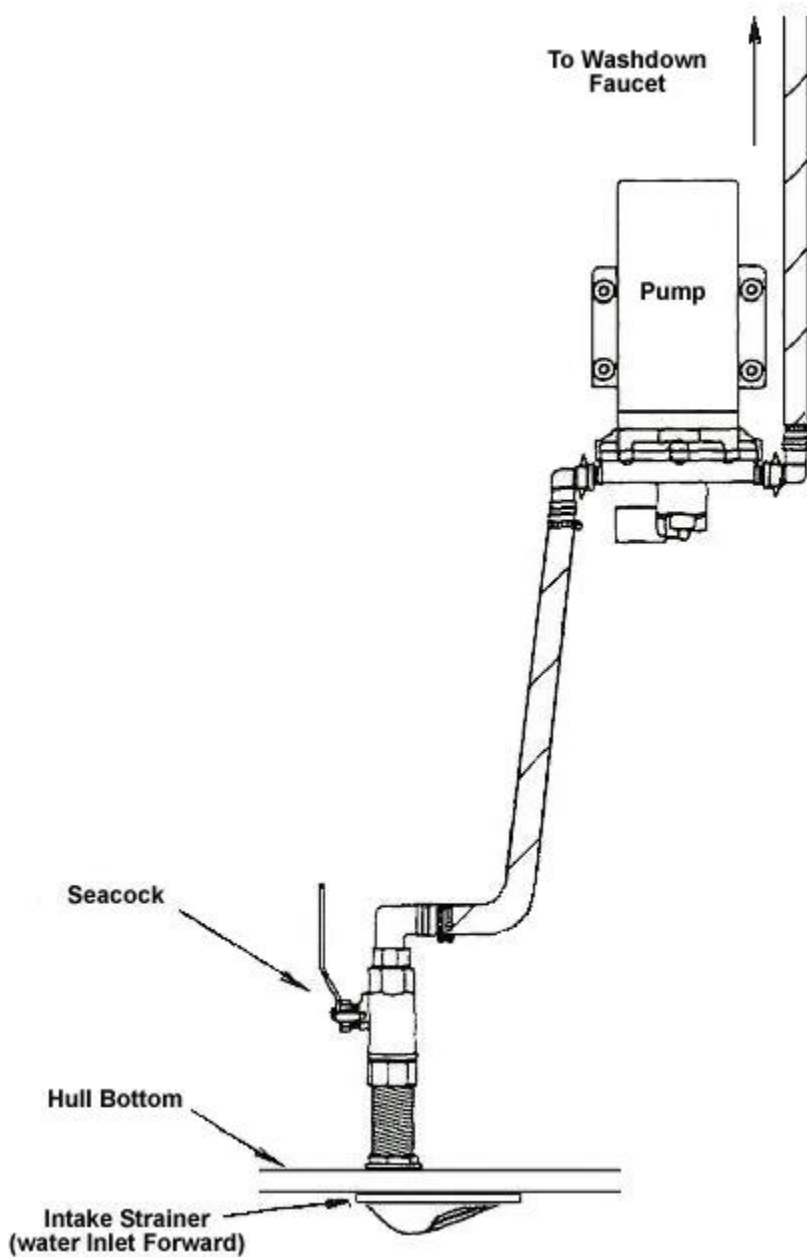



# MAINTENANCE AND SERVICE

**Part**

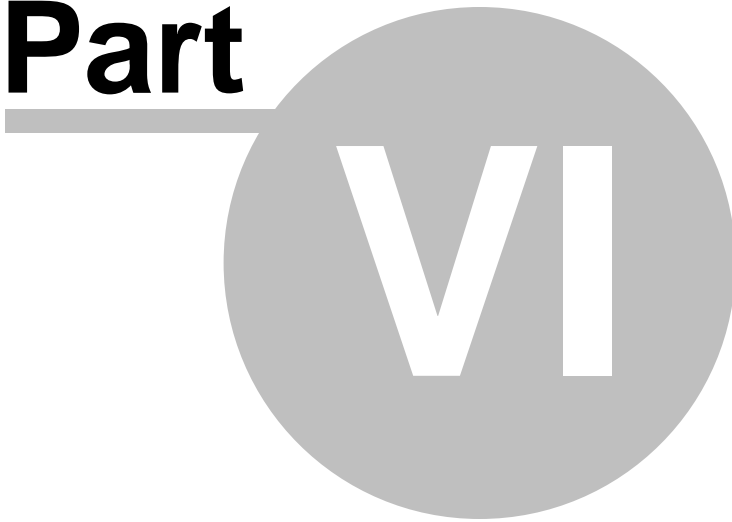

## 6 MAINTENANCE AND SERVICE

The amount of maintenance required to keep your boat operating properly and to maintain the appearance is dependent on many variables - frequency of use, salt or fresh water, geographic location, etc.

Always keep the bilge area clean and dry. Leaks found early and corrected will not cause damage. Do not allow grease, grime and dirt to build up.

Any condition found requiring corrective action should be done by a qualified mechanic. If you are away from home, contact your dealer for an authorized repair shop. Repairs should correspond with US Coast Guard specifications.

### 6.1 Exterior

Your hull and deck are constructed by the hand lay-up method using the highest quality fiberglass mat and woven roving fabric. This method of construction ensures a proper fiberglass-to-resin ratio and a uniform thickness, which together result in a much stronger boat than those constructed of "chopped glass." This is an expensive process, but ensures that your Jones Brothers boat is the strongest, most durable fiberglass boat possible.

Proper maintenance of your boat is not only a source of pride but is the key to maintaining your boat's value. A few simple steps will keep your Bateau looking showroom bright for years.

### 6.2 Fiberglass Finish

The exterior, or gelcoat, of your Bateau is a thin layer of resin with a color pigment. It is used for cosmetic purposes and makes routine maintenance relatively simple. Although gelcoat has a hard smooth surface, it does contain microscopic pores that will allow surface discoloration if not kept clean.

**Cleaning** - The best way to prevent discoloration is to hose with fresh water after each outing. Clean the boat regularly with a mild household detergent and plenty of fresh water. Use a sponge on smooth surfaces and the deck. A brush can be used on the non-skid areas. Do not use abrasive cleaners, and be sure to rinse away all grime and residue.

**Stained Gelcoat** - Gelcoat will age or dull naturally. Hulls often get discolored even when washed regularly. This can be caused by the sun, pollution, algae, old wax accumulation and the salt content of the water. The following process will restore a discolored finish and remove stains:

- Use fresh water to wet the trailer and ground around the boat. Try to leave the boat as dry as possible.
- Use a paint roller to apply Snobol toilet bowl cleaner to a dry hull. DO NOT get the cleaner on the decals. Also, try not to drip the cleaner on the trailer.
- After a few minutes the discoloration and rust stains will fade. Use fresh water to hose off the cleaner.
- Snobol will strip all the old wax - apply a new coat. A wax or polish containing Teflon is highly recommended.

**Waxing** - At least once a year apply a coat of wax. Check with a local dealer for advice on a suitable wax for your boating region. The wax film will seal the pores as well as enhance the looks of your boat. While waxing your boat, inspect the surface for any damage. If problems are found, have the damage corrected as soon as possible.

 <b>WARNING</b>	To prevent personal injury, DO NOT wax surfaces that may be walked on. Waxed gelcoat is very slippery, and will cause unsafe footing.
--	---

### 6.3 Repairing

Though gelcoat is a very durable material, it is susceptible to scratches, blistering, and web-like cracks (crazing) over time. It is elastic enough, however, to withstand strong blows while flexing with the hull's movement. Typical gelcoat problems are cosmetic and will not effect the structural integrity of your boat.

Many gelcoat imperfections such as nicks and scratches can be repaired by obtaining a color match patch kit. This kit can be purchased through your Jones Brothers Marine dealer. Acetone, the most suitable cleaning agent for gelcoat, can be purchased through your dealer. The patch kit has step by step instructions.

 <b>WARNING</b>	M.E.K. (Methyl ethyl ketone peroxide), gelcoat and acetone are flammable and hazardous chemicals, if not handled properly. Follow instructions on the containers carefully. After the gelcoat is catalyzed, it will soon heat up and put off fumes. When finished with catalyzed chemicals or when they start building up heat, submerge completely in water until cool.
--	--

### 6.4 Bottom Paint

If you leave your boat in the water for more than a few days, the hull bottom, below the waterline, should be treated with anti-fouling paint. This paint will help protect the bottom from marine growth and barnacles, which inhibit performance. Since anti-fouling paint slowly dissolves to prevent marine growth, inspection and cleaning of the hull bottom annually is advisable. Repaint whenever necessary. We suggest the use of an epoxy barrier coat, to be applied in conjunction with the anti-fouling paint, to help prevent blistering. For more information see your local dealer.

Another option for many recreational boaters is the "three day" rule. If you trailer your boat or keep it at a dry-stack facility, simply pull it out of the water every three days so the that hull can be washed and dried. By adhering to the three-day rule, especially in salt water, the damage and discoloration to the hull by algae, barnacles, or other aquatic growth can be minimized without the need for anti-fouling paint.

### 6.5 Canvas

Although canvas used for the optional top and console cover is made using the highest quality vinyl and latest sewing techniques, your boat's canvas will not be completely leak proof. The seam holes in the canvas may stretch and tend to leak. However, you can correct much of this problem by applying paraffin over the seams.

Please understand that Jones Brothers Marine does not warrant the fit and design of the canvas to be entirely watertight. For more information on your canvas, refer to the pamphlet provided in your boat package.

## MAINTENANCE

To maintain your boat's top and other canvas follow these steps:

- Wash canvas periodically with a heavy-duty detergent and warm water. Do not use petroleum-based or ammonia cleaners on canvas or clear vinyl as they will yellow.
- Lubricate the snap buttons and zippers with petroleum jelly or paraffin.
- Clean clear vinyl thoroughly with denatured alcohol, and then apply a protective layer of clear wax. Do not use paste wax as it will turn the vinyl yellow. This process should be repeated as necessary to maintain the protective wax coating.
- Store and secure canvas before trailering.
- Dry all canvas before storing to prevent mildew.
- Remove the top, front, and side panels and roll them up for storage. This procedure is necessary to prevent the front and side vinyl pieces from cracking. **NEVER FOLD THESE PIECES!**

## STORAGE

Consider the following steps when putting your folding top canvas option in the stored position:

- Fold the top and zip it into the canvas cover provided.
- Pivot the covered top into the stowed position on the foredeck. The canvas cover is equipped with a strap on each side and an eyelet in each strap. Place the eyelet over the male fasteners located on the port and starboard foredeck.
- Twist the male fasteners 90 degrees to engage.



### CAUTION

Secure the folded top when in the stowed position, this will prevent the loss of your canvas.

## 6.6 Upholstery

Your exterior vinyl cushions may be cleaned with a mild solution of household detergent and fresh water. Commercial cleaners for vinyl also work well. Follow the instructions provided on the label.

Since the seams of your cushions are not water proof, your upholstery should be stored in a dry place, or covered when not in use.

## 6.7 Plexiglas

The Plexiglas windshield can be cleaned with glass cleaner and a soft cloth.

 <b>CAUTION</b>	Never use acetone, benzene, carbon tetrachloride, lacquer thinner, or similar type solvents to clean the windshield. They penetrate the Plexiglas surfaces and cause hazing that will obstruct visibility.
--	--

## 6.8 Scuppers

All Bateau models have self-bailing cockpits, meaning that water on the cockpit floor drains overboard through drains rather than into the bilge. The stern drains (scuppers) have an external flap assembly which prevents water from back-flowing into the boat. Inspect the flaps periodically to make sure that they are free of debris.

## 6.9 Caulking

Deck fittings, bow rails, window, hatches, etc., have all been caulked with the highest quality material to ensure a waterproof joint with the boat. However, the working action of normal use will tend to flex the joint and eventually break down the seal between them. Periodically inspect the caulking for leaks. Repair the caulking when necessary or have your dealer do the repair.

## 6.10 Hardware Mounting

When drilling mounting holes in boat surfaces, make sure each hole is sealed properly. Sealing will prevent water leakage.

## 6.11 Hardware/Stainless Steel Rails Maintenance

Your hardware is made of laboratory grade 316 stainless steel, and needs regular cleaning to maintain its chrome-like finish. The key to maintaining your stainless steel is to keep it clean. Use a mild solution of soap and fresh water. If acid rain is a problem, you should rinse your boat with fresh water after each rainfall. Also, don't forget to rinse the hinges on baitwells and fishboxes. The hinges may need a small amount of silicone lubricant to avoid sticking.

### MAINTENANCE

- Wash with hot water and soap or a mild detergent or other commercially available stainless steel cleaner.
- After cleaning, rinse with fresh water. Wipe dry with a clean soft cloth to avoid water marks.
- If discoloration or deposits persist, use a non-scratching household cleanser or stainless steel polish with a little water and a soft cloth.
- For stubborn deposits, use a plastic scouring pad or a soft bristle brush with cleaner and water. Rub lightly in the direction of the polishing lines of the finish. Do not use too much pressure, it may mar the surface. **CAUTION:** Do not use abrasive cleaning products, pads, steel wool or steel brushes. These will damage the finish.

- Do not allow deposits to remain on the finish for long periods.

NOTE: Do not allow salt solutions, disinfectants, bleaches or other harsh cleaning chemicals to get on these surfaces. If these chemicals come in contact with your stainless steel, wash immediately, rinse and dry with a clean, soft cloth.

## 6.12 Fuel System

If you have a water separator in your fuel system, check the fuel line filter once a month and change if needed. This filter typically located in the engine well on the starboard side of the boat.

## 6.13 Engine Battery

The Bateau can be setup with a single starting battery, or use the optional dual battery configuration with a [Dual Battery Switch](#). Proper battery care and maintenance is extremely important.

They should be secured in a non-metallic tray to avoid electrolyte spills, and battery terminals should be covered by an insulated boot. Keep terminals clean by scrubbing them with a stiff brush and a mixture of baking soda and water. Afterwards, apply a light coat of grease.

 <b>CAUTION</b>	Remember, when disconnecting and reconnecting battery cables that the black cable(s) must be connected to the negative terminal, and the red cable(s) must be connected to the positive terminal of the battery. Reversing the cables will damage your system.
--	--

### Flooded Batteries

GEL and AGM batteries are sealed and do not require any additional maintenance. If you have flooded batteries, check the fluid level in each battery cell at least once a month. Fill the battery to the upper level with distilled water. Never overfill the battery.

When not in use, check the battery each month by using a battery hydrometer, which measures the specific gravity. The meter should read between 1250 and 1280.

 <b>WARNING</b>	To prevent personal injury, wear goggles, rubber gloves and a protective apron when working with a battery. Battery electrolyte can cause severe eye damage and burns to the skin. In case of spillage, wash area with a solution of baking soda and water.
--	---

**WINTERIZATION AND STORAGE**

**Part**



## 7 WINTERIZATION AND STORAGE

If your boat is going to be stored for the winter or for an extended period of time, there are some routine operations that should be taken care of. This information is presented as a general guide and the actual storage should be performed by a professional, qualified dealership. Prior to and during the storage process, the boat and its systems should be checked for any maintenance and repairs. Arrange maintenance and repairs during the storage period.

To avoid costly damage and delay when launching your boat, have it stored and winterized properly. Listed below are some of the general guidelines that should be considered before storage.

### 7.1 Boat Storage

If storing your boat on the trailer, raise and block the trailer axle to prevent tire deterioration. This is an excellent time to lubricate and pack the wheel bearings per manufacturer's instructions.

Indoor storage is advantageous in many ways, particularly if your climate produces ice and snow. The storage building should not be sealed airtight, but should be sufficiently ventilated. Ventilation is extremely important both around and through the boat.

To prevent "sweating," a breathable cloth or canvas cover should be used for outdoor storage. Consider building a frame to support the canvas. It should be slightly wider than the boat so the canvas will clear the rails and allow passage of air. The cover should be securely fastened so that winds cannot remove it or cause it to chafe the boat. A poor covering job will cost more than the price of a well-made cover.

### 7.2 Cleaning and Lubricating the Boat

Clean and wax your boat before storage. If you store your boat in the water, there may be a layer of growth on the bottom. As it dries, this debris will harden. Clean, scrub, and scrape the bottom promptly when the boat is removed from the water. Thoroughly remove marine growth and other foreign matter from the hull. Clean the inside of all hull openings, thru hull fittings and scupper drains. Inspect the hull bottom for any damage.

Check cleats and rails for corrosion and tightness. Clean all stainless steel. Use a good quality metal preservative like Formula 6-56 lubricant from CRC Chemicals on all metal surfaces to prevent salt water damage. Check for loose silicone, hinged, and unseated gaskets. Replace or tighten where necessary. Check all hinges for corrosion and lubricate.

### 7.3 Draining the Boat

Remove the bilge drain plug and open all valves and seacocks to keep the bilge dry. Store your boat with the bow elevated for drainage.

If your boat has a salt water washdown system and/or livewell, drain all the lines before storage.



## 7.4 Fuel System

This is a good time to have your fuel filter changed, if it has not been changed recently. The filter is typically located in the engine well on the starboard side of the boat.

## 7.5 Batteries

Fully charge the battery before storing. If you remove the battery, cover the terminals with grease to prevent corrosion and store in a cool, dry area on a wood board. Do not store the battery on concrete, because cold, moist surfaces will drain the battery.

If you leave the battery in the boat, ensure that the battery switch is in the off position. Wet cell (Flood) batteries have a high rate of self-discharge (6-7% per month). AGM and GEL batteries typically have a much lower discharge rate (3% per month). If possible, put the battery on a trickle charger.

## 7.6 Engines

Check your engine manual regarding the procedures for winterizing the engine. Follow these important instructions carefully, and your engine should survive the most severe weather conditions. Change all filters, and check hoses and clamps for leaks.

## 7.7 Storage Checklist

In addition to the previous explanations of winterization guidelines, the following checklist can be used as a guide to the proper storage procedures of your boat. Additional details should be added as needed for your personal inspection.

- Remove all loose and personal effects.
- Remove any detachable and valuable equipment and electronics. Store all electronics inside.
- Winterize all equipment as directed in the manufacturer's manual.
- Store cushions indoors to prevent mildew.
- Clean the exterior and interior of the boat. Remove all grease, oil, salt spray, etc.
- Remove all garbage. Clean storage compartments, fishboxes, and livewells. Prop fishbox lids open.
- Lubricate hinges, valves, back of fuse and instrument panels, and other surfaces that will rust.
- Check underwater items. Hardware should be in good condition and tight.
- Inspect electrical systems and have any repairs performed.

Jones Brothers Marine Manufacturing  
100 Bateau Blvd  
Morehead City, NC 28557

website: [www.jonesbrothersmarine.com](http://www.jonesbrothersmarine.com)  
tel: 252-240-1995  
fax: 252-240-1980